



WIND TURBINE RISK ASSESSMENT

CASTLETOWN PRIMARY SCHOOL

WIND TURBINE RISK ASSESSMENT

CONTENTS

Scope of Assessment	1
Summary	3
Site Risk Assessment	4
Project Planning Checklist	5
Contractor Management Checklist	6
Installation Checklist	7
Operation Checklist	8
Monitoring Checklist	9
Maintenance Checklist	10
Wind Speed Controls Info.	11
Risk Matrix Info.	12
Turbine Safety Zones Info.	13
Site Plan	14
Action Plan	15
BRE Report + Site Findings	16

LINKS

Small Scale Wind Turbine Risk Assessment – Scope of Assessment

This document is intended to provide a staged approach to assessment of the health and safety risks associated with the installation of a wind turbine generator at a Council building. The document advises on the current situation with the installations and reports on actions that are required following a full risk re-assessment and on advice received from the Building Research Establishment (BRE) on the best practice approach. The BRE report has been included along with information pertaining to the site being assessed.

The Risk Assessment tool has been devised to assist with a delivery process from conception to operation, and in this case has been applied retrospectively to the Council site.

In terms of the information that has been provided the document has been arranged into the following sections;

1. Summary Page (page 3)

The “Summary” of the Risk Assessment (RA) records information on the site, equipment that has been installed, persons involved in the risk assessment process and details of the risk assessment outcomes. This notes site specific details of the wind turbine location and surrounding area and what revisions and re-assessments have been carried out. This is intended to allow a quick and simple summary of the risk assessment.

2. Site Risk Assessment (page 4)

The “Site Risk Assessment” page details the RA process. It shows the identified risks, what risk rating has been applied along with how these are controlled and any residual risk or mitigating measures that are in place.

3. Project Planning Checklist (page 5)

The project planning list provides to record the actions necessary in reaching a decision regarding the suitability of any site to wind generation and details the standards of equipment and approvals met.

4. Contractor Management Checklist (page 6)

The contractor management checklist records that appropriate assessments have been undertaken in the selection of firms that are permitted to install or maintain the equipment.

5. Installation Checklist (page 7)

The Installation Checklist is intended to show that the health and safety requirements associated with the installation have been undertaken and recorded.

6. Operation Checklist (page 8)

The items on this page relate to the handover to site operation and record that documents and tools are available on site along with any training or emergency cover provision in place.

7. Monitoring Checklist (page 9)

The monitoring checklist is intended to record all issues in operation of the turbine and will provide a record that will inform the maintenance requirements and on-going safe operation of the equipment.

8. Maintenance Checklist (page 10)

The maintenance list will be a record of all servicing and routine upkeep to the site and turbine.

9. Wind Controls Guidance (page 11)

This section lays out the processes for addressing the conditions and what actions are to be taken.

10. Risk Matrix Information (page 12)

This page provides information on the risk outcomes

11. Turbine Safety Zone Information (page 13)

This information is taken from the Microrenewable Certification Scheme (MCS) wind guidance document and indicates the areas where consideration is to be given within the risk assessment.

12. Site Plan (page 14)

Details of the location of the wind turbine and site are given in this section.

13. Action Plan (page 15)

Listed here are actions that have resulted from the re-assessment process, detailing who is responsible and any response taken.

14. BRE Report + Site Findings (page 16)

A copy of the BRE report "Highland Council – Wind Turbine Risk Assessment Tools (Rev. A)" is provided. Also included are the site specific findings from the BRE site visit.

The Highland Council Wind Turbine Risk Assessment Tool

Scope: Applies to mast-mounted, free-standing wind turbines rated at 50kW or less ±

Site Detail

Site: Castletown Primary School
Location: Caithness
Environment: Rural

Turbine Detail

Manufacturer: Evance
Model: R9000
Capacity: 5 kW

Assessment

Assessment By: Martin Bell **Date:** 29/06/2012
RPO Consulted: Shaun Henderson **Date:** 29/06/2012
Approved By: **Date:**
Signature:
Re-assessment Date: 12/05/2013

**Re-assessment at least annually, linked to monitoring*

Residual risk dependent on increasing wind condition. Shut down in red zone

RISK SUMMARY	Initial Risk	Residual Risk	Residual Risk	Residual Risk
	3	0	0	0

[Risk Matrix](#)

NOTES:

Wind turbine installed in 2011 and supplements the electricity supply to the school. The wind turbine is located within the school grounds, approximately 26m from the school building. It is in the playground of the school and is contained within a 1m wooden fence.

The turbine is installed on a 15m column at the southern edge of the school boundary.

PHOTOS:



Revisions

Revision By: Michael MacDonald **Date:** 05/07/2012
Revision By: **Date:**
Revision By: **Date:**

Wind Turbine Risk Assessment Tool - Site Risk Assessment

Identified Project Risks	HAZARD			INITIAL RISK			CONTROLS			RESIDUAL RISK					NOTES	ACTION	TARGET DATE
	Identify Hazards	Hazard Effect	Persons at Risk	Calculate Risk Rating			Potential Control Measures			Hazard Severity		Likelihood		Risk Rating			
	Select from: Falls, Being trapped, Vehicles & plant, Electricity, Falling objects, Machinery, Burns, Lifting & handling, Fire, Moving objects, Harmful substances, Noise & vibration.	Describe all effects that may be realised if hazard was to occur.	Workforce Occupant Public	From matrix identify initial severity and likelihood for each hazard.	Describe fully all controls applicable for each hazard eg. If PPE is used it must be specifically described. If a control can only be verified by documentation then it must be available. All controls must reduce severity, likelihood or both.	From matrix identify severity with controls in place for each hazard.	From matrix identify severity with controls in place for each hazard.	Classify risk rating from matrix for each hazard	Wind speed measured on site	Wind speed measured on site	Wind speed measured on site	0-80mph	80-107mph	0-80mph			
Guide to Zones																	
1 Falling objects: Fall zone defined & protected (Zone 1) This is the immediate drop zone below the turbine	Falling Objects	Physical Injury and Damage	Pupils, Workforce and Public	3	1	3	a) Prevent access to zone 1. b) Regular maintenance and servicing regime on equipment along with visual and audible checks	3	3	1	1	3	3	There will be a fence erected around the turbine which excludes access to this zone. Maintenance and Servicing to take place twice annually; double the manufacturers recommended maintenance schedule.	HP&S	Maintenance and Servicing recurring October and April each year	
2 Tower/mast failure: Topple zone defined and protected (Zone 2) This is the area where conceivably the turbine could topple	Falling Objects	Physical Injury and Damage	Pupils, Workforce and Public	3	1	3	a) Procedure to preclude access to zone 2 in windy weather. (Refer to wind speed controls) b) Regular maintenance and servicing regime on equipment along with visual and audible checks c) Use of manufacturer's prescribed procedure and tools (including gin pole if specified) for lowering and raising tower.	3	3	1	1	3	3	Column selection, base design and fixing method prevents a) being necessary. Maintenance and Servicing to take place twice annually; double the manufacturers recommended maintenance schedule; by fully trained specialist contractors. Prevent access to zone 2 during maintenance procedure through contractor applied exclusion zone.	HP&S	Maintenance and Servicing recurring October and April each year	
3 Ejected objects: Ejection zone defined and protected (Zone 3) This is the area where parts of the turbine could land if they detach when the turbine is spinning	Falling Objects Moving Objects	Physical Injury and Damage	Pupils, Workforce and Public	3	1	3	a) Procedure to preclude access to zone 3 in adverse weather. b) Regular maintenance and servicing regime on equipment along with visual and audible checks	3	3	1	1	3	3	Maintenance and Servicing to take place twice annually; double the manufacturers recommended maintenance schedule. Apply Wind Speed Control measures if necessary. Icing is not a problem associated with small turbines, therefore not a concern in this instance.	RPO	Maintenance and Servicing recurring October and April each year	
4 Vandalism: Reachable area (Zone 4) and guy wires These are parts of the equipment that could cause injury or damaged through vandalism	Machinery Electricity	Physical Injury and Damage	Pupils and Public	2	1	2	No access path to the area. Guy wire shackles and adjusters locked.	2	0	1	0	2	0	Due to the location of the school, there is little likelihood of vandalism. Equipment to be inspected as part of the servicing. No guy wires at site. RPO confirmed that vandalism is not an issue.	RPO/HP&S	Maintenance and Servicing recurring October and April each year	
5 Vehicle collisions: Impact zone (Zone 5) This is the area where vehicles and structures can impact	Vehicles and Plant	Equipment Damage	Workforce and Public	0	0	0	No access path to the area	0	0	0	0	0	0	The only vehicular access to the site will be by maintenance contractor and HC grass cutting operatives.	N/A	N/A	
6 Tripping & collisions (with guy wires, base etc).	Falls	Physical Injury	Pupils, Workforce and Public	0	0	0	Site protected to avoid tripping / collision hazards, including guy wires where present	0	0	0	0	0	0	No Guy wires	N/A	N/A	
7 Vandalism: gin pole / lifting equipment	Lifting and Handling	Physical Injury	Pupils, Workforce and Public	2	1	2	Appropriate, secure storage allocated for gin pole / lifting equipment	2	2	1	1	2	2	The access to the equipment is restricted	HPS/RPO	Checked with twice annual service	
8 Exposed / accessible cables	Electricity	Electrocution	Pupils, Workforce and Public	0	0	0	All cables in good condition and protected or buried	0	0	0	0	0	0	There are no exposed cables	HP&S	N/A	
9 Overheating of generator, controller or inverter leading to fire or burn risk	Fire	Burns	Pupils, Workforce and Public	3	1	3	Regular maintenance and servicing regime on equipment with visual checks	3	3	1	1	3	3	The Equipment is to be serviced and tested twice annually; double the manufacturers recommended maintenance schedule.	HP&S	Maintenance and Servicing recurring October and April each year	
10 Base deterioration leading to risk of turbine toppling	Falling Objects	Physical Injury and Damage	Pupils, Workforce and Public	3	1	3	Checks for water pooling on base. Regular maintenance and servicing regime with visual checks.	3	3	1	1	3	3	The turbine is anchored to a concrete base designed and installed specifically for purpose as recommended by manufacturer.	HP&S	Maintenance and Servicing recurring October and April each year	
11 Ground stability. If ground subsides, there may be a risk of toppling	Falling Objects	Physical Injury and Damage	Pupils, Workforce and Public	3	1	3	For standard soil conditions (not including gravel, sand, or muck), foundations developed by the wind turbine manufacturer may be deemed acceptable for turbine installations of 20kW or less and will not require project-specific soils studies or a specific structural report.	3	3	1	1	3	3	The turbine is anchored to a concrete base designed and installed specifically for purpose as recommended by manufacturer.	HP&S	Maintenance and Servicing recurring October and April each year	
12 Lightning Strikes	Machinery	Equipment Damage	Pupils, Workforce and Public	3	1	3	Check mast & guys grounded. Surge arrestors may be fitted to electrical components.	3	3	1	1	3	3	The turbine is fitted with lightning protection that is tested twice annually	HP&S	Checked with annual service	

For general items related to planning, installation, maintenance, operation, contractor management and monitoring, please see separate checklists spread sheet

Wind Turbine Risk Assessment Tool - Project Planning Checklist

Highland Council Wind Turbines Check Lists	
Scope	Applies to mast-mounted, free-standing wind turbines rated at 50kW or less ±

Project Planning Phase Information:	COMPLETE
Verified by Council's competent representative (name):	Martin Bell

Project Planning Phase Checklists:		References	Details Submitted?	Date	Details
Safe Siting		MIS3003*	4.5		
1	Access plan			Y	29/06/2012 Contractor Method Statement
2	Site Security plan			Y	29/06/2012 Contractor Method Statement
3	Integration with site occupant activities			Y	29/06/2012 Contractor Method Statement
Product Compliance					
1	Turbine compliance with MCS standard: MCS006	MCS006		Y	29/06/2012 Evance R9000
2	Inverter CE marked			Y	29/06/2012 Evance R9000
3	Inverter compliant with grid connection guidance	ENA: G83, G59¥		Y	29/06/2012 Evance R9000
Planning & Regulatory Approval					
1	Copy of Building Warrant			Y	Self certified, not required
2	Acoustic performance estimate	MIS3003*	4.3.2	Y	Nov-10 CDMM Report
3	CNS Asset register - avoidance of aviation issues	MIS3003*	4.3.3	Y	Nov-10 CDMM Report
4	Shadow Flicker	MIS3003*	4.4	Y	Nov-10 CDMM Report
5	Visual Impact			Y	Nov-10 CDMM Report
6	Copy of Planning Approval			Y	Nov-10 CDMM Report
7	DNO permission to connect to grid	ENA: G59¥		Y	Not required

NOTE	
*These items refer to MIS3003 Iss. 3.1a. Please check you are using the latest version at: www.microgenerationcertification.org	
± Turbine rating is defined in the British Wind Energy Association Small Wind Turbine Performance and Safety Standard, February 2008	
¥ Energy Networks Association Guidance documents: G83/2 (<16A/phase) or G59/2 (>16A/phase).	
Prior permission is required for G59 or multiple G83 installations.	

Wind Turbine Risk Assessment Tool - Contractor Management Checklist

<i>Highland Council Wind Turbines Check Lists</i>	
Scope	Applies to mast-mounted, free-standing wind turbines rated at 50kW or less ±

Contractor Management Phase Information:	COMPLETE
Verified by Council's competent representative (name):	Martin Bell

	Contractor Management Checklist	References		Details Submitted?	Date	Details
1	Assessment of installing contractor complete			Y		MCS Certified
2	Assessment of operation and maintenance contractor complete			Y		MCS Certified
3	Housing Property Services consulted on contractor selections			Y		Normal Tendering Process

NOTE						

Wind Turbine Risk Assessment Tool - Installation Checklist

Highland Council Wind Turbines Check Lists	
Scope	Applies to mast-mounted, free-standing wind turbines rated at 50kW or less ±

Installation Phase Information:	COMPLETE
Verified by Council's competent representative (name):	Martin Bell

Installation Phase Checklists:		References	Details Submitted?	Date	Details
Principle Contractor					
1	Principle Contractor identified		Y	02/12/2010	PAD0072 Tender Acceptance
2	Principle Contractor or their designated installer MCS certificated		Y	02/12/2010	Sangster Electrical
Contractor Risk Assessment & Method Statement					
1	Movement of materials		Y	29/06/2012	Contractor Method Statement
2	Movement of plant		Y	29/06/2012	Contractor Method Statement
3	Excavation		Y	29/06/2012	Contractor Method Statement
4	Access		Y	29/06/2012	Contractor Method Statement
5	Traffic management		Y	29/06/2012	Contractor Method Statement
6	Segregation		Y	29/06/2012	Contractor Method Statement
7	Electrical isolation		Y	29/06/2012	Contractor Method Statement
8	Electrical connection		Y	29/06/2012	Contractor Method Statement
9	Site Security		Y	29/06/2012	Contractor Method Statement
10	Switchgear		Y	29/06/2012	Contractor Method Statement
11	Elec. Permit to Work		Y	29/06/2012	Contractor Method Statement
12	Machinery Hazards		Y	29/06/2012	Contractor Method Statement
13	Structural engineer's report		Y	29/06/2012	Contractor Method Statement
14	Working at height		Y	29/06/2012	Contractor Method Statement
15	Health Risks		Y	29/06/2012	Contractor Method Statement
16	Interaction with site occupant activities		Y	29/06/2012	Contractor Method Statement
17	Climbing (unauthorised)		Y	29/06/2012	Contractor Method Statement
18	CDMC		Y	29/06/2012	Contractor Method Statement
Installation commencement					
1	Pre-install safety meeting with council completed		Y	02/12/2010	Pre-start Meeting
Commissioning evidence					
1	Commissioning certificate	MIS3003*	6	17/06/2011	MCS-00066842-C
2	Evidence of correct erection & levelling**			17/06/2011	MCS-00066842-C
3	Evidence of correct mounting bolt/nut torque settings**			17/06/2011	MCS-00066842-C
4	Evidence of correct guy wire adjustment (if applicable)**			17/06/2011	MCS-00066842-C
5	Evidence of correct concrete consistency e.g. certificate of conformance**			17/06/2011	MCS-00066842-C
6	Evidence of correct base reinforcement structure installation**			17/06/2011	MCS-00066842-C
Security:					
1	DNO permission to connect to grid		Y		

NOTE

*These items refer to MIS3003 Iss. 3.1a. Please check you are using the latest version at: www.microgenerationcertification.org

**Conforming to manufacturer's specification

Wind Turbine Risk Assessment Tool - Operation Checklist

Highland Council Wind Turbines Check Lists	
Scope	Applies to mast-mounted, free-standing wind turbines rated at 50kW or less ±

Operation Phase Information:	COMPLETE
Verified by Council's competent representative (name):	Martin Bell

	Operation Phase Checklist	References	Details Submitted?	Date	Details
1	Risk assessments communicated to Head Teacher		Y	28/06/2012	Meeting with Shaun Henderson
2	Risk assessments communicated to site Maintenance Officer		Y	29/06/2012	M.O George Crawford
3	Inspection & Maintenance records stored on site		Y	28/06/2012	MB checked
4	Commissioning documents stored on site		Y	28/06/2012	MB checked
5	Operating Instructions stored on site		Y	28/06/2012	MB checked
6	Emergency shutdown procedures available on site		Y	28/06/2012	MB checked
7	On-site responsible officer & deputy trained (esp. Use of emergency procedures & contacts)		Y	28/06/2012	MB checked
8	All necessary keys to locks, panels, etc available on-		Y	28/06/2012	MB checked
9	Change of staff procedure in place		Y	28/06/2012	Not necessary
10	High wind procedure in place		Y	28/06/2012	
11	Wind speed forecasting / weather warnings		Y	02/10/2012	RPO to be aware of weather forecasts.

NOTE	
1. Location of Keys: At Turbine and Janitors Office, with O&M Manual for Wind Turbine. Backup key holder: Maintenance Officer. Secondary Responder: G&A Bernie.	
2. Weather Forecasting: RPO to be aware of weather forecasts, TECS to provide weather warning info to RPO.	
3. School Holiday periods: RPO to assess any actions necessary, which may be dependant upon personnel available, weather conditions, use of site etc.	

Wind Speed Control Measures: The RPO is to be aware of wind conditions up to 80mph and implement any control measures they deem appropriate. Wind speeds above 80mph, RPO to implement the control measures listed on page 11.

Wind Turbine Risk Assessment Tool - Monitoring Checklist

<i>Highland Council Wind Turbines Check Lists</i>	
Scope	Applies to mast-mounted, free-standing wind turbines rated at 50kW or less ±

Monitoring Phase Information:	COMPLETE
Verified by Council's competent representative (name):	Martin Bell

	<i>Monitoring Checklist</i>	<i>References</i>	<i>Details Submitted?</i>	<i>Date</i>	<i>Details</i>
1	Issue reported to Council's competent representative		Y		No issues
2	Issue reported to Council's Health & Safety Team		Y		No issues
3	Maintenance monitoring officer appointed		Y	29/06/2012	Martin Bell
4	Risk assessment annual review*		Y		12/05/2013

NOTE					
*Provide date of risk assessment annual review in detail section					

Wind Turbine Risk Assessment Tool - Maintenance Checklist

Highland Council Wind Turbines Check Lists	
Scope	Applies to mast-mounted, free-standing wind turbines rated at 50kW or less ±

Maintenance Phase Information:	COMPLETE
Verified by Council's competent representative (name):	Martin Bell

	Maintenance Phase Checklist	References	Details Submitted?	Date	Details
	Key holders				
1	Designated turbine key holders	*Name in details	Y	28/06/2012	RPO
2	Back-up turbine key holder	*Name in details	Y	28/06/2012	G.A Barnie / George Crawford
	Contractor's Pre-planned Maintenance Risk Assessment				
1	Access routes & procedure		Y		New Maintenance Contract awarded, contractor standing by for go ahead. Method Statement submitted, risk assessment to be completed when contractor visits site.
2	Working at height		Y		
3	Work platforms		Y		
4	Electrocution hazards		Y		
5	Machinery Hazards		Y		
6	Trip hazards		Y		
7	Occupant's activities assessed		Y		
	Contractor's Reactive Maintenance Risk Assessment				
1	Access routes & procedure		Y		New Maintenance Contract awarded, contractor standing by for go ahead. Method Statement submitted, risk assessment to be completed when contractor visits site.
2	Working at height		Y		
3	Work platforms / emergency procedure		Y		
4	Fragile surfaces		Y		
5	Electrocution hazards		Y		
6	Machinery Hazards		Y		
7	Trip hazards		Y		
8	Occupant's activities assessed		Y		

NOTE
Existing maintenance contract in place, new contract to be awarded shortly
Location of Keys: At Turbine and Janitors Office, with O&M Manual for Wind Turbine Backup key holder: Maintenance Officer. Secondary Responder: G&A Barnie.

[Return to Assessment](#)

Wind Speed Specific Controls

0 mph	80 mph	107 mph
Normal Operation		Limit Operation
These measures must be applied when the wind speed is within the range of 0mph - 80mph		These measures must be applied when the wind speed consistently exceeds 80mph
1	Audible & visual checks	1
2		2
3		3
4		4
0 mph	80 mph	107 mph

NOTE
 The turbines installed by the council have been designed and tested to operate safely in wind speeds up to 134mph. The Highland Council has applied a further 20% safety margin to this wind speed so as to reassure building occupants and members of the public. This means that no Highland Council turbine will be allowed to operate in wind speeds exceeding 107mph. Measures have also been put in place to ensure that when high winds (>100mph) are forecast the wind turbine is isolated and made safe before being subjected to the extreme conditions.

[Return to Summary](#)

[Return to Assessment](#)

		SEVERITY / CONSEQUENCE		
Risk Rating		1. Negligible	2. Moderate	3. Major
LIKELIHOOD	1. Very unlikely	1	2	3
	2. Possible	2	4	6
	3. Probable	3	6	9

1-3 Low	May be acceptable; however, due care should be employed and task reviewed to see if risk can be reduced further.
4-6 Med	Task should only proceed with appropriate authorisation. Where possible the task should be redefined and/or measures employed to reduce the residual risk.
7-9 High	Task must not proceed. It should be redefined or further control measures put in place to reduce risk. Controls should be re-assessed prior to the task commencing.

[Return to Assessment](#)

Turbine siting safety zones

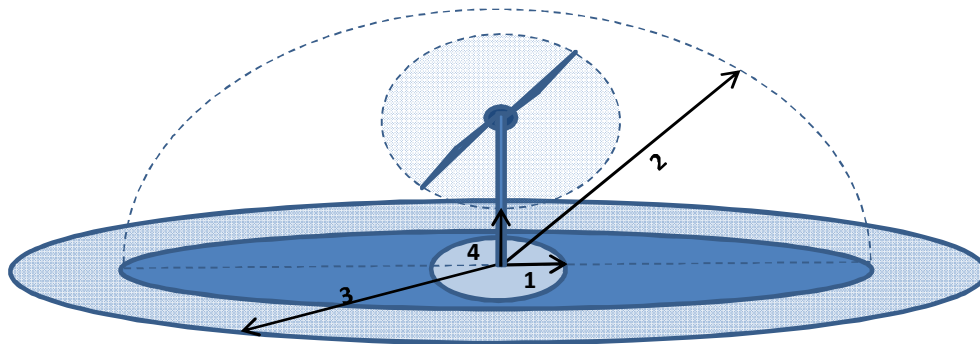

Zone	Extent	Typical hazard
1	Circle around base	Fall zone: Hazard if anything were to fall from turbine
2	Hemisphere around base	Topple zone: Hazard if the mast were to topple (incl. margin)
3	Circle around base	Ejection zone: Hazard if something were to be ejected from the spinning rotor.
4	Reachable area	Vandalism: Lowest point of rotating parts above the ground or easily accessible point.
5	Varies	Impact: Hazard from vehicle impacts

Derived from MIS3003 Iss. 3.1a

THIS IS THE PLAN REFERRED TO

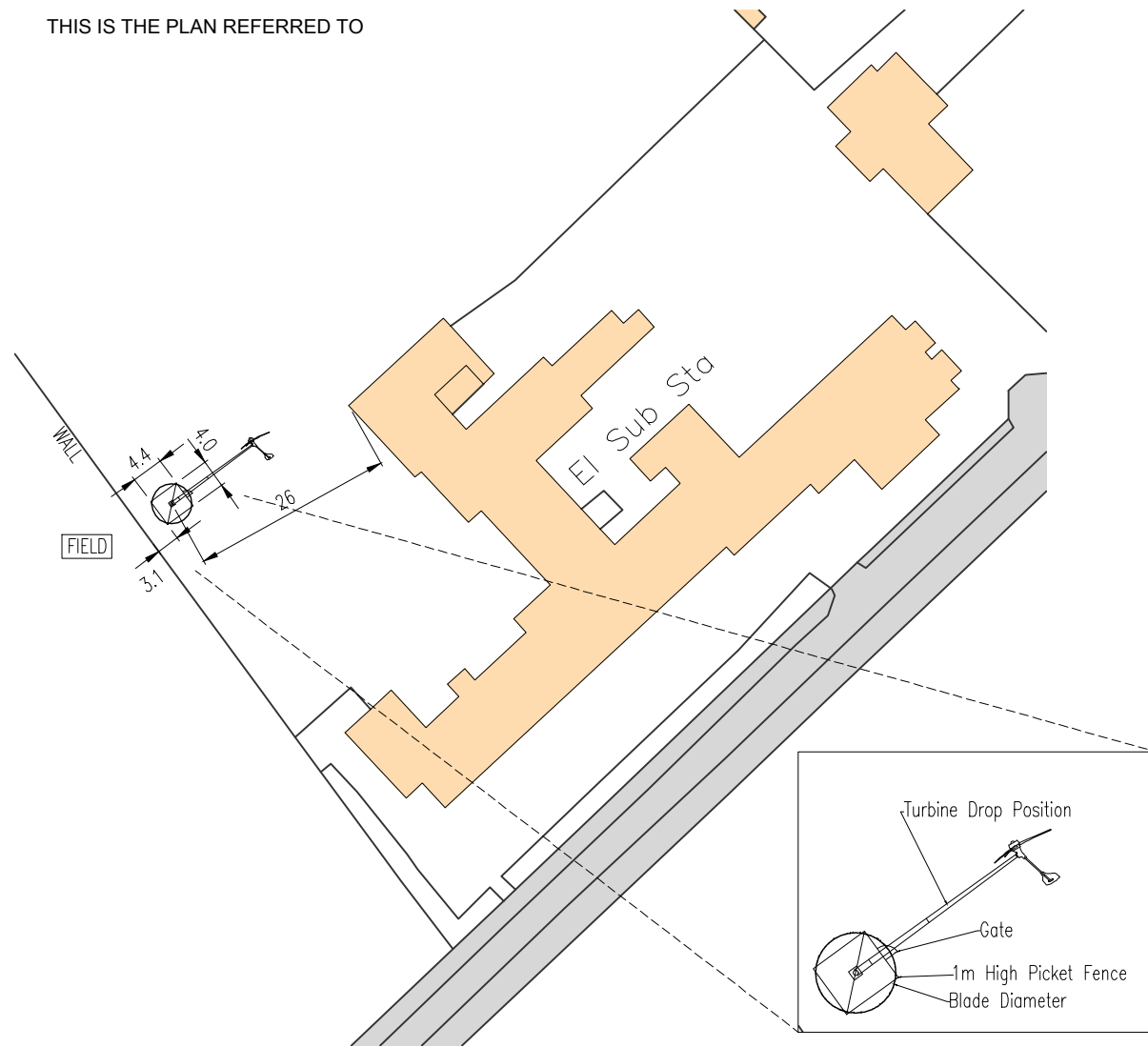

View of Turbine (looking west)



View of School and Turbine



Turbine Base



View of School and playing field around Turbine

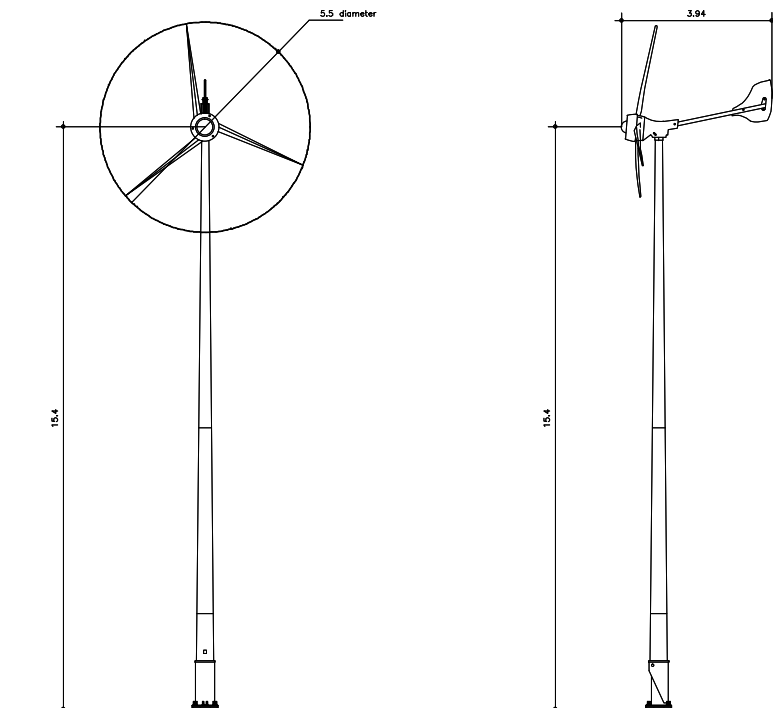

Preliminary				
REV.	PURPOSE OF ISSUE	BY	CHECKED	DATE
DESCRIPTION				

HOUSING AND PROPERTY SERVICE Steve Barron Director of Housing and Property				Kinmylies Building Leachkin Road Inverness. IV3 8NN Tel. (01463) 703500 Fax (01463) 703555				 The Highland Council Comhairle na Gàidhealtachd	
CLIENT Energy and Sustainability				CONTACT Martin Bell					
PROJECT Wind Turbine Site Assessments				DRAWING TITLE Castletown Primary School					
				PURPOSE OF ISSUE					
SCALE	DATE	DRAWN BY		PAPER	PROJECT NUMBER	AGENT	SERIES	UNIQUE No.	REVISION
1:1000	May 2012	MB		A3	PAD0072	E			
		CHKD BY	EB						

Small Scale Wind Turbine Review

Castletown Primary School - Action Plan

Tasks Completed to date;	Completed By;	Date;	Sign Off:
1. Turbine suspended 9th May 2012	Martin Bell	09/05/12	Steve Barron 17/10/12
2. Risk Assessment process review	Martin Bell	June '12	
3. Site visit and survey 18th May 2012	Martin Bell	16/08/12	
4. BRE Site visit and findings	BRE	11/07/12	
5. Consultation with industry bodies	Martin Bell	May/June '12	
6. Consultation with turbine manufacturers	Martin Bell	May/June '12	
7. Revised Risk Assessment Process	Martin Bell	Sept. '12	
a. Introduce high wind procedure plan			
b. Include checklist provided by BRE			
8. Meeting with RPO to discuss revised Risk Assessment Process 28th June 2012	Martin Bell	28/06/12	

BRE Site Findings;	Comments;	Date:	Sign Off:
1. Turbine fence, no padlock present	3. To be monitored during maintenance and by MO.	11/07/12	Steve Barron 17/10/12
2. Adjacent ground used as school play area / football pitch		11/07/12	
3. Water pooling on turbine foundation	11/07/12		
4. Turbine lowering equipment not located on site	11/07/12		
	4. Held by maintenance contractor.		

Actions required to allow turbine switch-on;	Completed By;	Date:	Sign Off:
1. Install 1.8m Weld-mesh fence and padlock.	Martin Bell	TBC	Steve Barron 17/10/12
2. Provide handheld anemometer to RPO for high wind procedure		TBC	
3. Refresh MO with emergency shutdown procedures		16/08/12	
4. Maintenance contractor to energise turbine, following annual service		TBC	

Reviewed By: Steve Barron, Director – Housing & Property **Date:** 17/10/2012

The image features a decorative graphic consisting of numerous thin, yellow, curved lines that originate from a central point on the left and fan out towards the right. The lines are set against a solid dark blue background on the left side of the page, which transitions into a white background on the right side. The lines create a sense of movement and depth, resembling a stylized wind turbine or a series of overlapping paths.

bre

**Highland Council –
Wind Turbine Risk
Assessment Tools
(Revision A)**

Prepared for:
Eddie Boyd
Principal Engineer,
Housing and Property Services,
Highland Council

Client report number 278405

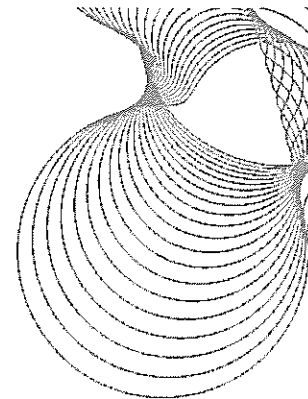

Prepared by

Name Steve Pester & Colin Sinclair

Position Principal Consultant and Senior Consultant

Signature *C. Sinclair*

Approved on behalf of BRE

Name Wayne Ward

Position Commercial Director

Date 10 September 2012

Signature *Wayne Ward*

BRE Scotland
Orion House
East Kilbride
Glasgow, G75 0RD
T + 44 (0) 1355 576200
F + 44 (0) 1355 576210
E eastkilbride@bre.co.uk
www.bre.co.uk



This report is made on behalf of BRE. By receiving the report and acting on it, the client - or any third party relying on it - accepts that no individual is personally liable in contract, tort or breach of statutory duty (including negligence).

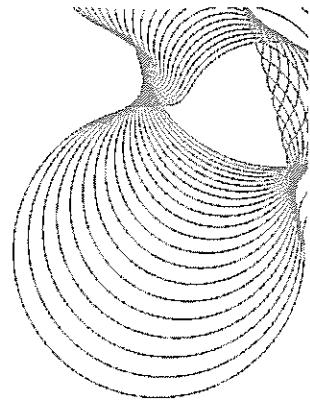

Contents

1	Introduction	1
2	Development of the risk assessment tools	3
	Methodology	3
	Wind Turbine Planning Checklist Tool	4
	Wind Turbine Design/Operational Risk Assessment Template Tool	5
3	Historical installations	8
	Site Condition Surveys	8
4	Conclusion and recommendations	11
	References	12
	Appendices	13

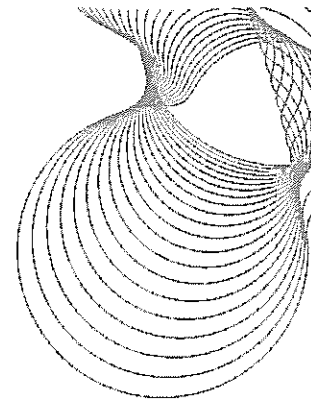

1 Introduction

This report forms part of an initiative by the Highland Council to further develop its risk assessment processes relating to small wind turbines sited on school land or other Council property.

The small wind industry has only recently begun to develop. The last five years have seen a shift from a cottage industry, inhabited by a few pioneers, to a more professionally managed engineering and installation market sector. The sector growth has been spurred on by the availability of financial incentives and the regulatory bodies have had to work hard to put in place basic quality standards as the demand rockets upwards. The volunteers who staff the Microgeneration Certification Scheme technical working group for small turbines have introduced some very good basic technical standards for products and installers, however in reality it is still early days and the procedures and standards designed to regulate the small wind sector are still evolving. One aspect of this is the complex issue of safe siting and operation. Only in the recently released, latest issue of the MCS installer standard¹ has the issue been addressed at all, and the information therein only constitutes general guidance and there is limited background research to back up this guidance.

This may at first seem surprising, after all many large turbines have been installed across the UK over the past 20 years and such projects implement stringent standards in order to maintain product performance and H&S compliance. The key difference between the large and small wind sectors is that the former are never sited within centres of population, whereas small turbines have been increasingly appearing on school playing fields, car parks, community land and domestic buildings, in relatively high numbers over the past 5 years. Add to this the likelihood of installation companies whom voluntarily impose safety zones around its turbines, potentially being at a commercial disadvantage versus their competitors, and it can be seen why, in the face of no official research, guidance or regulation, rules on risk assessment and safety have not been universally implemented.

This project has been initiated following concern over some incidents with small turbines and the need to ensure that the risks associated with having these technologies in close proximity to the public are understood, eliminated, minimised or controlled, as appropriate, and so is a step in the right direction for addressing the above concerns.

Although risk assessment processes are not yet standardised or widely available within the industry, it has been possible to identify and highlight the principal risks using a variety of sources. A central part of this initiative is the development of a risk assessment spread sheet tool and this is described in the sections below.

Highland Council's existing processes

The Highland Council provided a spread sheet which forms the basis of their existing risk assessment process. Whilst this identifies and assesses some of the main risks attendant with small wind turbines, the tools developed as part of this project incorporates further detail including new information and procedures from recent standards.

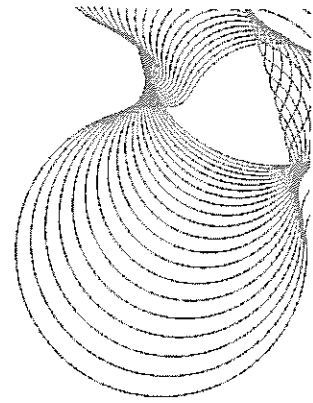

In particular, siting is crucial for the successful deployment of small wind turbines both from the point-of-view of safety and with regard to energy yield. Therefore, the new tools identifies and incorporates a number of siting safety factors to ensure that the Council's processes are aligned with the most up to date industry guidance available.

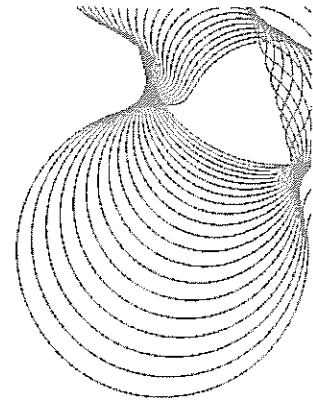

2 Development of the risk assessment tools

Methodology

Although such risk assessment processes are not standardised, or widely available, within the small wind industry, it has been possible to identify and highlight the principal risks using a variety of sources such as the technical standards from the Microgeneration Certification Scheme (MCS)², British Wind Energy Association³ Small Wind Turbine Performance and Safety Standard, as well as practical experience gained by BRE staff through site inspection visits under the MCS programme. The Highland Council report, *Review of Risk Management arrangements covering provision of Wind Turbines within Highland Council property establishments*⁴, also contains useful information.

Following discussions, it became apparent that there was a need for two standalone spread sheet tools to deal with the various aspects of wind turbine risk assessments as follows:

- A project planning stage checklist, and
- An updated design/operational risk assessment template for project implementation (developed in conjunction with Highland Council).

The development of these tools is discussed in the next two sections however both tools are heavily influenced by recent micro and small scale wind turbine guidance produced by the Microgeneration Certification Scheme which sets out a number of turbine safety zones as described in figure 1 below.

Zone	Extent	Typical hazard
1	Circle around base	Fall zone: Hazard if anything were to fall from turbine
2	Hemisphere around base	Topple zone: Hazard if the mast were to topple (incl. margin)
3	Circle around base	Ejection zone: Hazard if something were to be ejected from the spinning rotor.
4	Reachable area	Vandalism: Lowest point of rotating parts above the ground or easily accessible point.
5	Varies	Impact: Hazard from vehicle impacts

Figure 1: Safety Zones

It should be noted that this is the first time that safety zones of this nature have been included in MCS guidance and although the definition of these zones and the hazards likely to be presented within the respective zones goes a long way to helping those considering, designing or installing a small scale wind turbine assess site safety, it does not provide definitive guidance or recommendations on the size or scale of some of these zones but rather requires that each of the defined zones be suitably evaluated for risk on a site by site basis. It should also be borne in mind however that although individual risk assessments should take cognisance of all relevant and available guidance, it will be subjective and will depend upon a

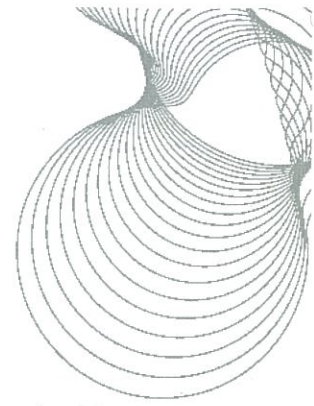

large number of site specific factors that will need to be assessed on their own individual merits. The tools developed as part of this process can however largely assist in delivering a robust, technical, wind turbine risk assessment that takes account of the newly defined zones and puts in place measures to mitigate any risk involved.

Wind Turbine Planning Checklist Tool

The first tool developed is a wind turbine planning checklist (WTPC) tool which serves as a guide to address, manage and monitor the design and technical requirements from project inception through operation, on-going management and monitoring of a wind turbine project. The tool provides a simple “Yes/No” checklist under each of its sections that allows a project reviewer to critically assess important wind turbine health and safety issues. The tool is structured using the project stages as identified in the Council’s report⁴³ as follows:

1. Project planning stage
2. Contractor Management
3. Installation phase
4. Maintenance phase
5. Operation phase
6. Monitoring

So as to clearly delineate the phases, each one is given a separate tab within the spread sheet tool as described below. Under each tab is a checklist identifying the risks to be addressed, and it is intended that each list will be completed and signed off before commencement of the phase.

Project planning phase

This tab is intended to be used during the initial stages of a project and contains the all-important siting issues mentioned above. The main areas addressed are: safe siting, product compliance and planning approval.

The safety zones identified within the MCS installer standard are incorporated into this section of the tool (i.e. as per figure 1 above), along with a ‘zones’ diagram (see figure 2 below) explaining the purpose and physical extent of each zone. Guidance on zone dimensions is given, where possible, however, some risks and resultant zone dimensions will need to be identified on a case-by-case basis as no formal methodology is currently available.

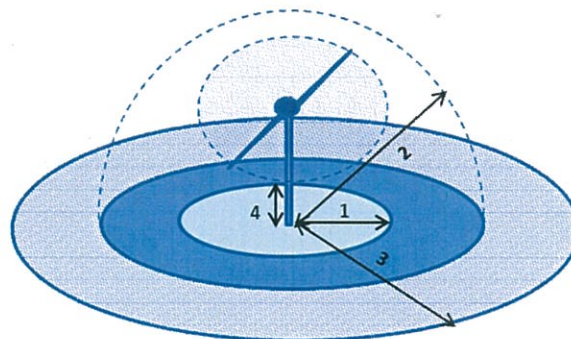
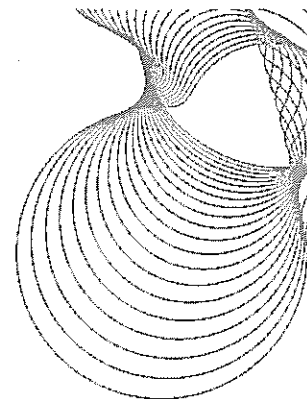

Figure 2: Turbine Siting Safety Zones



An example of this is the 'Ejection zone', which is defined as the area over which a turbine could possibly throw material or failed parts. The zone dimensions will depend on the turbine rotor speed, mass of ejectable material, land topology, as well as the frequency and size of congregations around the turbine. In addition, the risks are likely to be reduced should it be ensured that a turbine is well-maintained (via a defined and controlled programme), and special precautions are taken in conditions where it is been assessed that there is a likelihood of ice forming on the turbine blades; however assessment of these issues will need to be completed by the responsible person completing the WTPC or detailed risk assessment, as discussed later.

Installation phase

Most of the information in this section will be provided by the installing contractor. The main areas addressed are: principle Contractor identification and credentials, contractor risk assessment & method statement, installation commencement, commissioning evidence and turbine mounting.

Maintenance phase

The main areas addressed are: Manufacturer's recommended maintenance programme, key holders, risk assessment for contractor's planned maintenance, risk assessment for contractor's reactive maintenance. It is essential that all aspects are fully addressed and controlled in order for on-going safe maintenance to occur.

Operation phase

The main areas addressed are: on-site documentation, designation and training of responsible personnel and emergency procedures.

Managing contractors

The main areas addressed are: the assessment of the installing and maintenance contractor(s) and liaison with the Council's Housing and Property Services department.

Monitoring

The main areas addressed are the reporting of any in-service issues. The appointment of a responsible officer to monitor the maintenance programme is also included as a 'top level' control.

In summary, the WTPC tool will serve as a useful checklist throughout the critical phases of project development and deployment and the tool can also be maintained and/or updated throughout the life of a project. The tool can also provide a useful audit trail on important wind turbine site safety issues. In addition, it can also serve as a useful tool for reviewing historic processes and their effectiveness, when completed retrospectively. E.g. The "operation" checklist includes questions such as: have risk assessments been communicated to the site responsible officer; are operating instructions stored on site; is there a "change of staff" procedure in place" etc., which will enable anyone conducting a retrospective review to assess the effectiveness of the Council's internal procedures concerning a range of issues.

Wind Turbine Design/Operational Risk Assessment Template Tool

Highland Council requires a technically robust, auditable, risk assessment procedure to ensure that the design/operational risk assessments of wind turbine installations are undertaken appropriately. This is especially important given the recent update to the current industry accepted turbine guidance as discussed

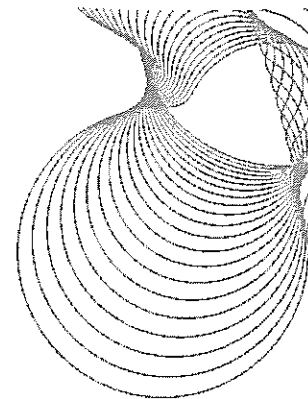

earlier in this report. Therefore, in addition to the WTPC tool, a detailed technical risk assessment tool was also developed which can be used for this purposes.

Highland Council's existing 'Wind Turbine Risk Assessment Tool' was used as the basis for the development of the revised tool. The existing tool was used as it was both well developed and functional which allowed it to be developed to include the latest revisions to wind turbine guidance. An additional benefit of developing the tool from the existing model was that Council operatives will be conversant with the tool, its language and its method of operation and that it will also more easily allow for completion of individual site assessment in line with the Council's existing internal guidance on design and operational risk assessments.

So as to clearly delineate the phases of risk assessment, there are a number of separate tabs within the spread sheet as below.

1. Revised site risk assessment
2. Risk rating, control info
3. Risk Register
4. Risk summary
5. General Risks
6. Turbine Siting Safety Zones

As the tool builds upon the existing Housing and Property Services Risk Assessment model this report will not describe in detail the working of the tool or the calculation of risk rating, but will rather give a brief overview of the tool before setting out how the tool has been developed to provide detailed consideration of safety issues conversant with the latest wind turbine guidance.

Tool Overview:

"Section 1: Revised site risk assessment" provides the user the opportunity to identify risks that may be applicable to the project. For each identified risk, the tool allows the hazards to be identified (i.e. what is the hazard, what is the hazard effect, who are at risk?), before an initial risk rating is automatically calculated using the Council's pre-determined scoring methodology. Thereafter the user is able to define relevant "controls" to mitigate the risks and subsequently assess the "residual risk rating" i.e. the risk rating after the control measures are deemed to be in place.

"Section 2: Risk rating, control info" sets out the various definitions of risk "severity" and "likelihood" as well as the risk rating scores which underpin the Highland Council risk assessment methodology e.g. a risk rating of 7-14 is defined as "medium: the task should only proceed with appropriate authorisation. Where possible the task should be redefined and/or measures employed to reduce the residual risk."

"Section 3: Risk Register" and "Section 4: Risk Summary" are output schedules which effectively summarise all the residual risks and summarise how each of the respective risk should be handled, what actions should be implemented to manage them, who is responsible for overseeing the actions, identification of key stakeholders pertinent to the risk and after what period the risk should be reviewed.

"Section 5: General Risks" provides an opportunity for additional risk to be identified and included in the analysis. The format of this section is identical to that of Section 4: Risk Summary, but includes for the additional provision of a i) cost impact, and ii) timescale impact, as well as performance impact.

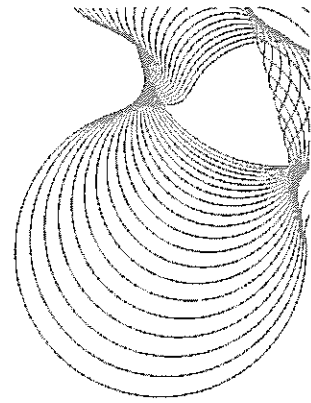

The tool will therefore allow a user to fully detail and document all potential risks associated with a small scale turbine installation whilst evaluating its risk rating; required control measures/risk mitigation actions; forward action plan including contingency plan; identify responsible parties; and timescale for review of the risk assessment.

A review of the excel spread sheet tool template can provide detailed information on the risk issues included therein, however these can be summarised as follows:

- Falling objects: Fall zone defined & protected (zone 1)
- Tower/mast failure: Topple zone defined and protected (zone 2)
- Ejected objects: Ejection zone defined and protected (zone 3)
- Vandalism: Reachable area (zone 4) and guy wires
- Vehicle collisions: Impact zone (zone 5)
- Tripping & collisions with guy wires
- Vandalism: turbine lowering/lifting pole or other lifting equipment
- Exposed / accessible cables
- Overheating of generator, controller or inverter leading to fire or burn risk
- Base deterioration leading to risk of turbine toppling
- Any other site specific risks?

It should be borne in mind that the tool developed as part of this process is a generic template tool and, as such, the above risk items are provided as guidance only. In addition the tool may not necessarily include all risks that may be present at all sites. The developed tool does however provide a methodology that Council operatives can utilise to undertake site specific risk assessments. The contents of the tool reflects current best practice guidance but should be reviewed, at least on an annual basis to keep it up to date.

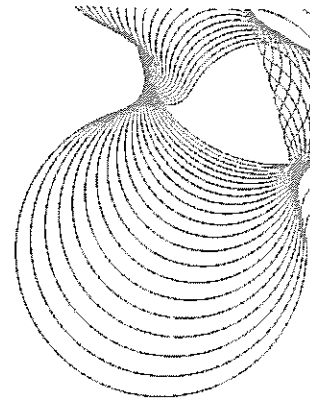

3 Historical installations

Inevitably, there are now many hundreds of small turbines installed across the UK in places which, under the scrutiny of newly developed processes and recommendations, may be questionable. The question is how should these be assessed for risk at the present time? There is no formal guidance to address this, either legislative or coming forward from industry. The sensible and prudent approach is to continuously develop risk assessment procedures as new information and guidance becomes available and review each site against these revised procedures. The process currently being undertaken and the subject of this report is the Highland Council's proactive approach to the safety of their installations and the initial assessment of installations in order to identify any potential safety-related issues.

It is recommended that the council implement an inspection and maintenance regime of increased frequency with six monthly inspections for these installations, immediately before and after the winter season, which contains the majority of the annual wind energy production.

On-going engagement with the HSE and Renewable UK on this subject may also be useful. Renewable UK has stated aims as follows:

- Take an active lead on health and safety matters as they directly relate to the risks particular to our sector
- Work in partnership with lead organisations and key stakeholders where the health and safety risks and activities interface with our industry
- Engage and consult with members and the wider stakeholder community to ensure health & safety issues are given the profile and priority required
- Actively inform and communicate health and safety matters in a suitable and timely manner to members and key stakeholders.

Safety notices and wind-related H&S events are also posted on the organisation's website.

Site Condition Surveys

To assist with the Council's review of existing sites; BRE have completed site surveys for fourteen Council sites where small scale wind turbines were installed prior to the introduction of the recent guidance. The survey findings are included in Appendices A to N; the results of which will assist the Council in undertaking a detailed site specific risk assessment of each respective site. The majority of the surveys were completed after the Council had taken the decision to switch off a number of the turbines until such time as their in-house reviews were completed. The surveys did however raise a number of common issues, as follows, which the Council should look to address with immediate effect where turbines remain operational. Where turbines are currently de-energised the works should be completed before the devices are re-energised.

- Provision of on-site documentation: many sites did not appear to have appropriate documentation including operating instructions and emergency shut-down procedures. In addition many sites were unable to provide access keys to the turbine mast access hatch, a provision which may be

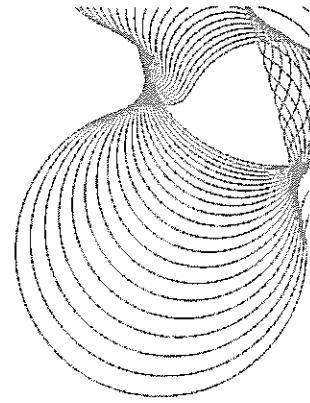

necessary depending upon the specification of turbine installed and the manufacturer's recommended stopping instructions.

- Provision of on-site labelling: many sites did not have appropriate safety warning labelling (e.g. "dual supply" labelling to identify to anyone working on the property's electrical system that the system includes a generator in addition to the utility supply) or display system schematics as formally required by the wiring regulations. This presents a health and safety issue.
- Water pooling on turbine foundations: water pooling was evident on a number of foundations. Consideration may wish to be given to the introduction of adequate drainage to prevent water from collecting on the foundations which can in turn penetrate openings in the foundation causing damage over time via freeze/thaw action.

In addition a number of urgent / priority issues were raised within the site reports as follows:

- Bower Primary School
 - The turbine was found to be producing a louder noise than would be expected under normal operation.
 - Action: Instruct the manufacturer, installer or maintenance contractor to undertake an investigation, service inspection and remedial works prior to re-energisation.
- Inver Primary School
 - The turbine earth was disconnected.
 - Action: Instruct the manufacturer, installer or maintenance contractor to reconnect the earth.
 - The ground surrounding the turbine appears to be a sandy constituency which may result in the turbine requiring a more substantial foundation than at a site where ground conditions may have been more favourable. The visible top section of the foundation was found to measure approximately 6x5m suggesting that the design of the foundation had been increased to account for the ground type although the commission did not extend to confirming the suitability of the foundation by calculation or any other means.
 - Action: Review design details to ensure foundations designed to suit ground conditions
- Gairloch Academy
 - Anecdotal evidence from the janitor suggests that the turbine has been struck by lightning twice since its installation which has resulted in failure of various system components including an inverter. Consideration may therefore wish to be given to the introduction of suitable lightning protection in the area
 - Action: investigate potential for lightning protection to site
 - The ground surrounding the turbine appears to be a sandy constituency which may result in the turbine requiring a more substantial foundation than at a site where ground conditions may have been more favourable. This commission did not extend to confirming the suitability of the foundation for the site by calculation or any other means
 - Action: Review design details to ensure foundations designed to suit ground conditions
- Stoer Primary School
 - The spare ways in the local 'turbine' distribution board were not all safely sealed using blanks or similar.

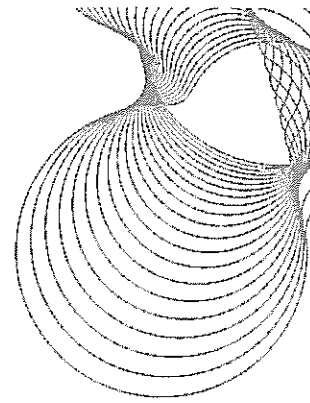

- Action: Instruct the installer or maintenance contractor to undertake works to remedy this fault
- Acharacle Primary School
 - No turbine earth was witnessed during the survey although this does not necessarily mean that one does not exist.
 - Action: Investigate if earth is present and take steps to make visible or ensure one is installed
- Portree Waste Transfer Station
 - The turbine earth tape was not properly secured to the turbine structure i.e. the tape had not been drilled but had rather only been clamped down using the bolt head.
 - Action: Instruct the installer or maintenance contractor to undertake works to remedy this fault

It is recommended that Council undertake these works with immediate effect where turbines remain operational. Where turbines are currently de-energised the works should be completed before the devices are re-energised.

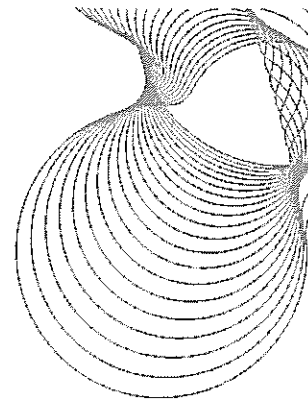

4 Conclusion and recommendations

A description of the turbine safety situation in the UK has been conducted by the Council and is well documented in its report⁴.

This report describes further background and details relating to the introduction of updated standards in relation to safe siting. The primary purpose of this report has been to introduce the new risk assessment template tools intended to form the basis of an improved methodology for the Highland Council. Some risks (for example, ejection zones) will need to be quantified on a case-by-case basis, but the tool can be adapted and refined in the light of experience and evolving standards; and should provide a solid foundation on which to proceed.

The Council is taking a proactive approach to meeting obligations in a changing market and should the Council adopt the proposed procedures then it will represent a robust and comprehensive assessment process that takes account of current legislation and best practice guidance. Risk assessments should be undertaken by suitably competent personnel and it should also be borne in mind that legislation and guidance in this area is an evolving topic, and that regular review of these processes will be required to ensure that processes remain robust over the longer term

Continued engagement with interested parties such as the HSE, Renewable UK, the MCS and BRE will provide timely information, as it becomes available, and will also help to provide field data to inform policy.

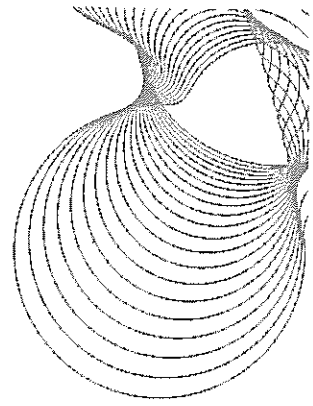

References

¹ Microgeneration Installation Standard: MIS 3003, *Requirements For Contractors Undertaking The Supply, Design, Installation, Set To Work Commissioning And Handover Of Micro And Small Wind Turbine Systems* Issue 3.1a

² Microgeneration Certification Scheme information: www.microgenerationcertification.org

³ British Wind Energy Association is now called *Renewable UK*: www.bwea.com

⁴ *Risk Management arrangements covering provision of Wind Turbines within Highland Council property establishments*, Stuart Duncan, 29 November 2011

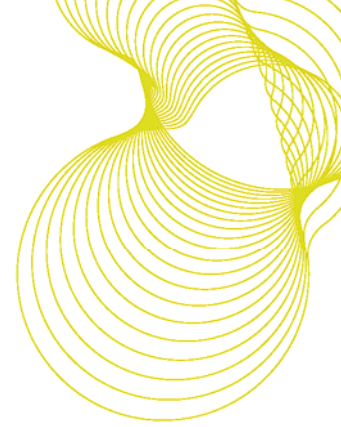

Appendix B – Castletown Primary School - Site Condition Report

Turbine: Evance R9000 Horizontal Axis Wind Turbine
Support: 15 metre tower mast on foundation

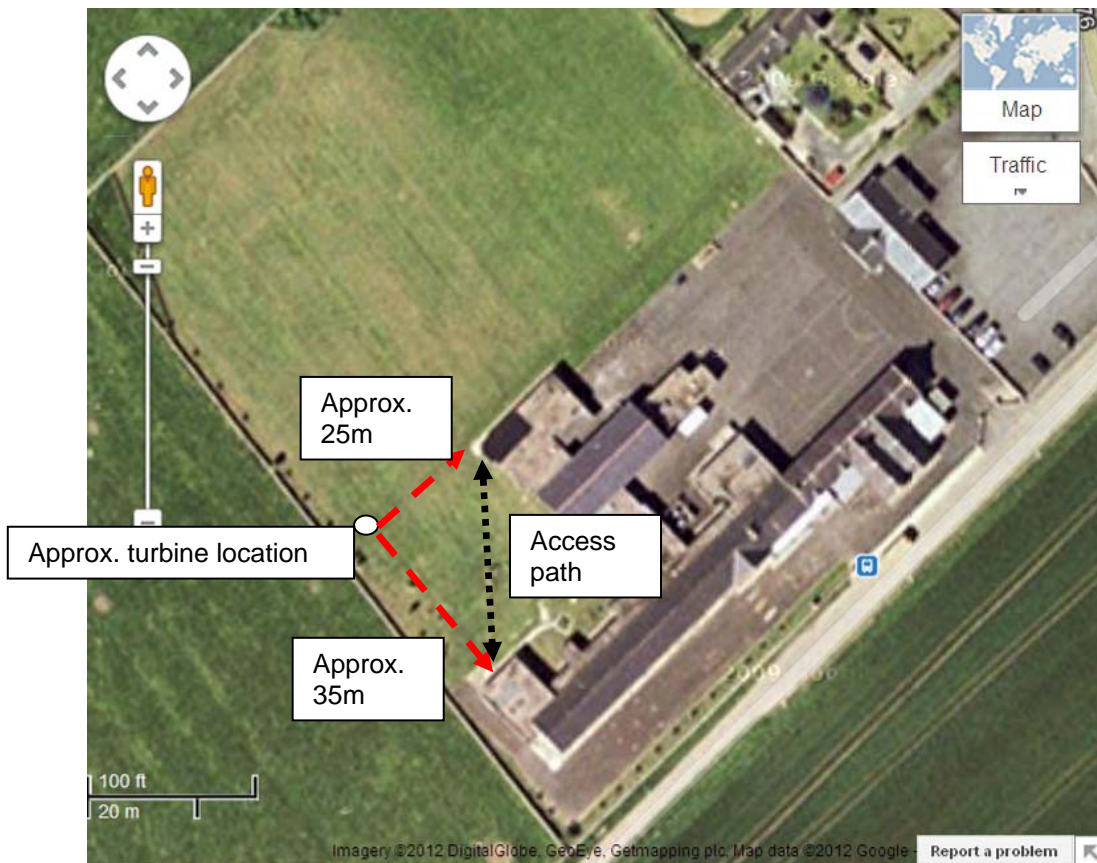
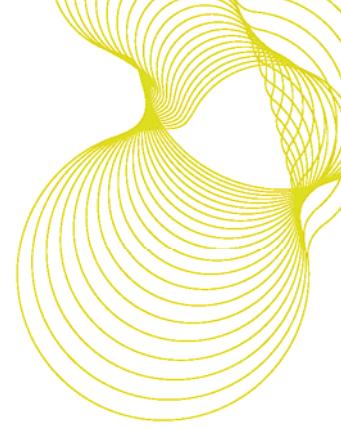

Figure B1 – Site plan



Site photographs:



Figure B2



Figure B3



Figure B4

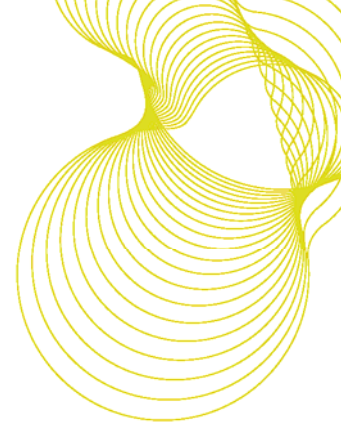

Site Findings:

- A square timber fence (1.2m (h)) of approx. 4.2m x 4.2m is in place around the turbine base. This fenced area includes a gate permitting access to the foundation and mast. The gate included a bolt fixing. No lock was present on the gate.
- The school ground to the North of the turbine is currently used as a play area / football pitch. The area to the East of the turbine includes an access path diagonally across the grassed area as shown in Figure B1
- Water pooling was witnessed on the foundation.
- The key to the turbine mast was present on site.
- No turbine lowering equipment was seen in the vicinity.
- An O&M manual for the wind turbine installation was present on site. The contents of the manual was not checked in detail however it was found to include the turbine manufacturers recommended emergency stop procedure.



hutchinson
engineering

Head Office & Distribution Centre
Everite Road
Widnes
Cheshire
United Kingdom
WA8 8PT

Main Line: +44 (0) 151 422 9990
Accounts: +44 (0) 151 420 9733
Projects: +44 (0) 151 420 9732
Purchasing: +44 (0) 151 420 9742
Design: +44 (0) 151 420 9737
Fax: +44 (0) 151 420 5100

info@hutchinsonengineering.co.uk
www.hutchinsonengineering.co.uk

Tim Sammon,
Evance Wind Turbines, Ltd.,
Unit 6, Weldon Road,
Loughborough.
LE11 5RN

8th October, 2012

Dear Tim,

In response to your request, I would confirm that all our foundation designs, including root, pad and piled solutions, are designed in accordance with EC 2 (BS EN 1992-1-1:2004), BS EN 1997-1:2004, BS 4449:2005 and, where still applicable, BS 8004.

The designs cater for exposure conditions which include ground water, inclement weather, varying ambient temperatures, etc., controlled by specifying such items as minimum steel content, concrete mix, steel grade and concrete cover.

In light of the above, in our opinion, small amounts of ponding on the top surface will not cause any concerns regarding the structural integrity of the foundation for at least the design life of the installation.

Yours sincerely,

Ivan Brocklehurst, BSc. MISTructE
Technical Director