

Notes
 © Crown Copyright and database rights 2023 AC0000849432
 1. All dimensions in millimeters.
 2. All units shall be hydraulically pressed and
 comply with relevant sections of BS EN
 1340:2003.

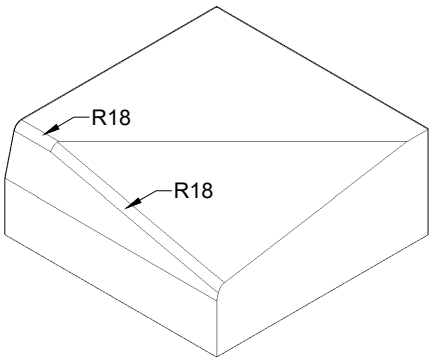

Isometric View (LH unit)

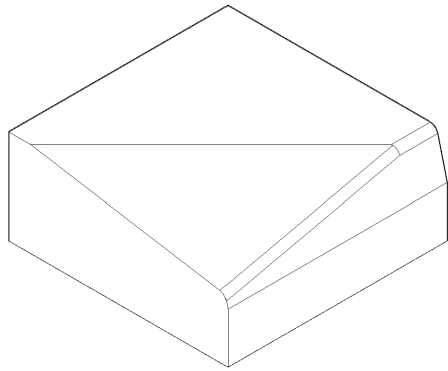

Isometric View (RH unit)

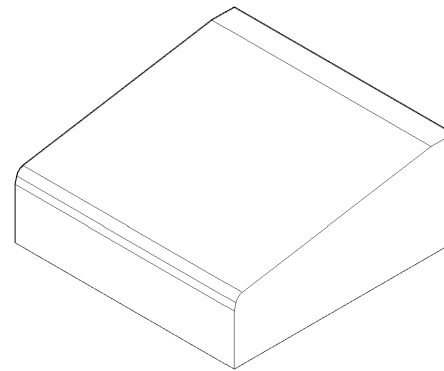

Isometric View

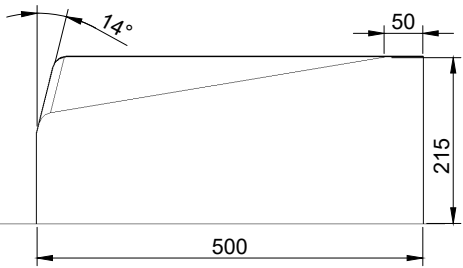

End Elevation (LH unit)

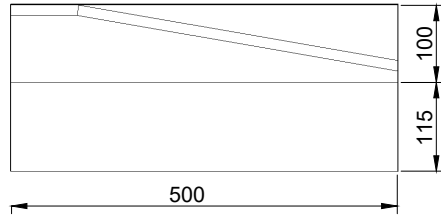

Front Elevation (LH unit)

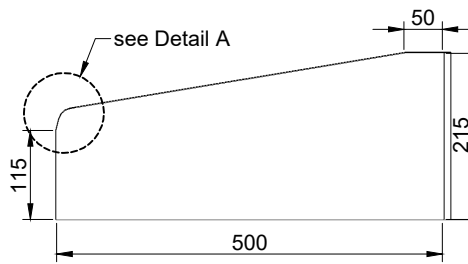

End Elevation

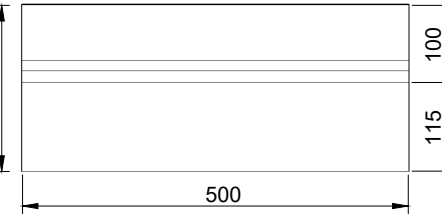

Front Elevation

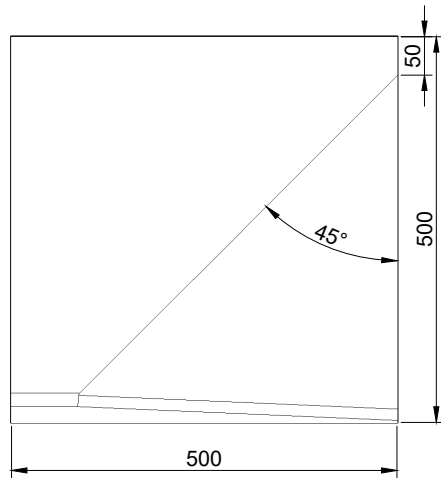

Plan (LH unit)

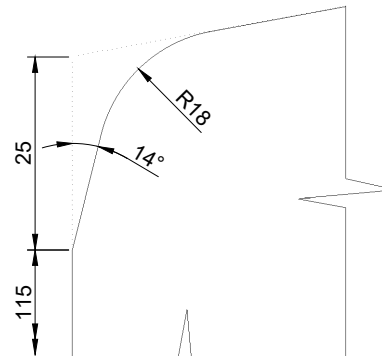

Detail A

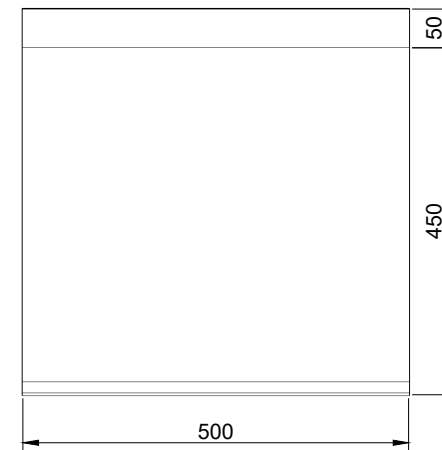

Plan

HB2-to-ramp transition unit

Driveway ramp unit

Revision Details	Drawn by	Checked by	Checked Date	Suffix



Project: Standard details. Series 1100:
 Kerbs, footways, cycleways and paved areas

Title: Footway crossing - light vehicle access: units

Scale (at A4): Not to scale

Drawn	JC	Date	05/2024
Checked	CHK	Date	05/2024

Drawing No:	SD/1100/10	Rev:	1
-------------	------------	------	---